

## Locking Device

optional  
nickel-plated version  
optional full stainless  
steel version

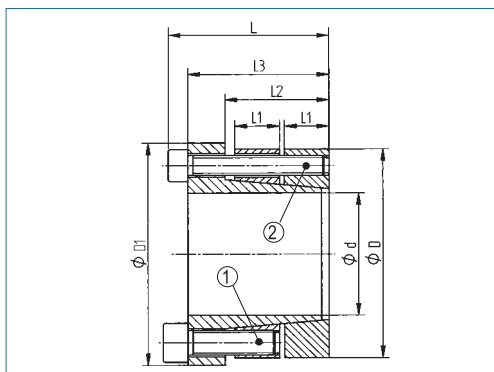

transmittable torque	high
surface pressure on hub	medium
self-centering	yes
axial movement of the hub during assembly	no
height D/d	high
overall length	long

Order Code

**KBS 62 - 240 x 310**

Type                      Ød                      ØD

Recommended finishing tolerances of contact surfaces are: shaft h8 / hub H8

Inner / Outer Ø dxD	Dimensions					Screw				Torque			Surface pressure on				Mass kg
	D1 mm	L1 mm	L2 mm	L3 mm	L mm	1	TA 1 Nm	2	TA 2 Nm	T1 Nm	T2 Nm	T Nm	1 Shaft Hub N/mm²	2 Shaft Hub N/mm²	Hub N/mm²		
30 x 60	66	15	36	48	56	M8	41	M6	17	620	330	950	243	121	131	66	0.8
32 x 65	71	15	36	48	56	M8	41	M6	17	660	450	1110	227	112	154	76	0.9
35 x 65	71	15	36	48	56	M8	41	M6	17	720	490	1210	208	112	141	76	0.9
38 x 70	76	15	36	48	56	M8	41	M6	17	980	530	1510	239	130	130	70	1.0
40 x 70	76	15	36	48	56	M8	41	M6	17	1030	560	1590	227	130	123	70	1.0
42 x 80	86	18	42	57	67	M 10	83	M8	41	1420	1080	2500	237	124	181	95	1.6
45 x 80	86	18	42	57	67	M 10	83	M8	41	1520	1160	2680	221	124	168	95	1.5
48 x 85	91	18	42	57	67	M 10	83	M8	41	2030	1230	3260	259	146	158	89	1.7
50 x 85	91	18	42	57	67	M 10	83	M8	41	2110	1290	3400	249	146	152	89	1.6
55 x 90	96	18	42	57	67	M 10	83	M8	41	2320	1410	3730	226	138	138	84	1.7
60 x 95	101	18	42	57	67	M 10	83	M8	41	3040	1850	4890	249	157	152	96	1.9
65 x 100	106	18	42	57	67	M 10	83	M8	41	3290	2010	5300	230	149	140	91	2.0
70 x 115	121	24	56	74	86	M 12	145	M 10	83	5300	3550	8850	239	145	160	97	3.6
75 x 125	131	24	56	74	86	M 12	145	M 10	83	6620	4430	11050	260	156	174	105	4.3
80 x 125	131	24	56	74	86	M 12	145	M 10	83	7060	4730	11790	244	156	163	105	4.0
85 x 135	141	24	56	74	86	M 12	145	M 10	83	7500	5020	12520	230	145	154	97	4.7
90 x 135	141	24	56	74	86	M 12	145	M 10	83	7950	5320	13270	217	145	145	97	4.3
95 x 150	156	26	67	82	96	M 14	230	M 12	145	11300	8390	19690	255	162	190	120	6.1
100 x 150	156	26	67	82	96	M 14	230	M 12	145	11900	8830	20730	242	162	180	120	5.6
110 x 160	166	26	67	82	96	M 14	230	M 12	145	13100	9710	22810	220	151	164	113	6.1
120 x 170	176	26	67	82	96	M 14	230	M 12	145	14300	10600	24900	202	143	150	106	6.5
130 x 190	196	30	71	95	111	M 16	355	M 14	230	24200	17600	41800	253	173	185	126	10.5
140 x 200	206	30	71	95	111	M 16	355	M 14	230	26000	19000	45000	235	164	171	120	11.3
150 x 210	216	30	71	95	111	M 16	355	M 14	230	27900	20400	48300	219	157	160	114	11.8
160 x 220	226	30	71	95	111	M 16	355	M 14	230	29700	21700	51400	205	149	150	109	12.5
170 x 250	256	40	92	122	142	M 20	690	M 16	355	49400	31600	81000	227	154	145	99	24.1
180 x 250	256	40	92	122	142	M 20	690	M 16	355	52300	33500	85800	214	154	137	99	21.5
190 x 270	276	40	92	122	142	M 20	690	M 16	355	69000	44100	113100	254	178	162	114	26.3
200 x 270	276	40	92	122	142	M 20	690	M 16	355	72700	46500	119200	241	178	154	114	23.6
220 x 290	296	40	92	122	142	M 20	690	M 16	355	79900	51100	131000	219	166	140	106	25.5
240 x 310	316	40	92	122	142	M 20	690	M 16	355	105000	66900	171900	241	186	154	119	27.6
260 x 330	336	40	92	122	142	M 20	690	M 16	355	113000	72500	185500	222	175	142	112	29.6
280 x 365	371	45	108	144	168	M 24	1200	M 20	690	148000	102000	250000	223	171	153	117	45.5
300 x 385	391	45	108	144	168	M 24	1200	M 20	690	159000	109000	268000	208	162	143	111	48.3
340 x 425	431	45	108	144	168	M 24	1200	M 20	690	252000	173000	425000	257	206	176	141	53.9
380 x 465	471	45	108	144	168	M 24	1200	M 20	690	322000	221000	543000	263	215	180	147	59.6